

STEALTH I DC MANUAL

TECH SUPPORT 1-888-588-4506WEB www.ChargeOnTheRun.com

BLACK UNIT IS 24/36 ONLY

PLEASE READ AND UNDERSTAND YOUR NEW PRODUCT

IMPORTANT MESSAGE: Before installing your newly purchased STEALTH I DC charging system be sure to read the following instructions completely, regardless of your familiarity with electricity or electrical systems. You must follow the instructions contained in this manual. This unit is an electrical component and can be damaged when installed wrong. If after reading, you have any questions please call our toll free tech support number (1-888-588-4506).

ALWAYS WEAR SAFETY GLASSES WHEN WORKING WITH BATTERIES!

THE STEALTH I CONCEPT: The Stealth I DC accepts power from any source. Whether you are using your engines alternator or AC power the Stealth I DC operates the same. The Stealth I DC and AC connects to your cranking battery and when your cranking battery reaches full charge, the Stealth I DC turns on and steps up the voltage to your trolling motor or aux. batteries. With the Stealth I volt meter in place and properly used the full battery maintenance program will keep you from going dead on the water as designed.

The **Stealth I DC** charging system gets it's power directly from your engine's cranking battery. When in operation, the state-of-the-art technology applies on-demand charging voltage to your marine trolling or aux. batteries so they receive only the charging current required to replace energy that has been consumed. The Stealth I **Smart Charging Circuit Design** works to ensure your cranking battery voltage will not fall below 13.0VDC, thus, providing plenty of stand-by power to start your engine. The Stealth I DC also works to prevent "over-charging" of your trolling or aux. batteries by monitoring output voltage and then automatically switching to a float mode to maintain optimum charging. The life of the batteries will be longer due to the charging method. (See Question & Answers at the end of the manual.)

STEALTH I DC (BLACK UNIT) is 24 and 36 volt system only

FIGURE 1

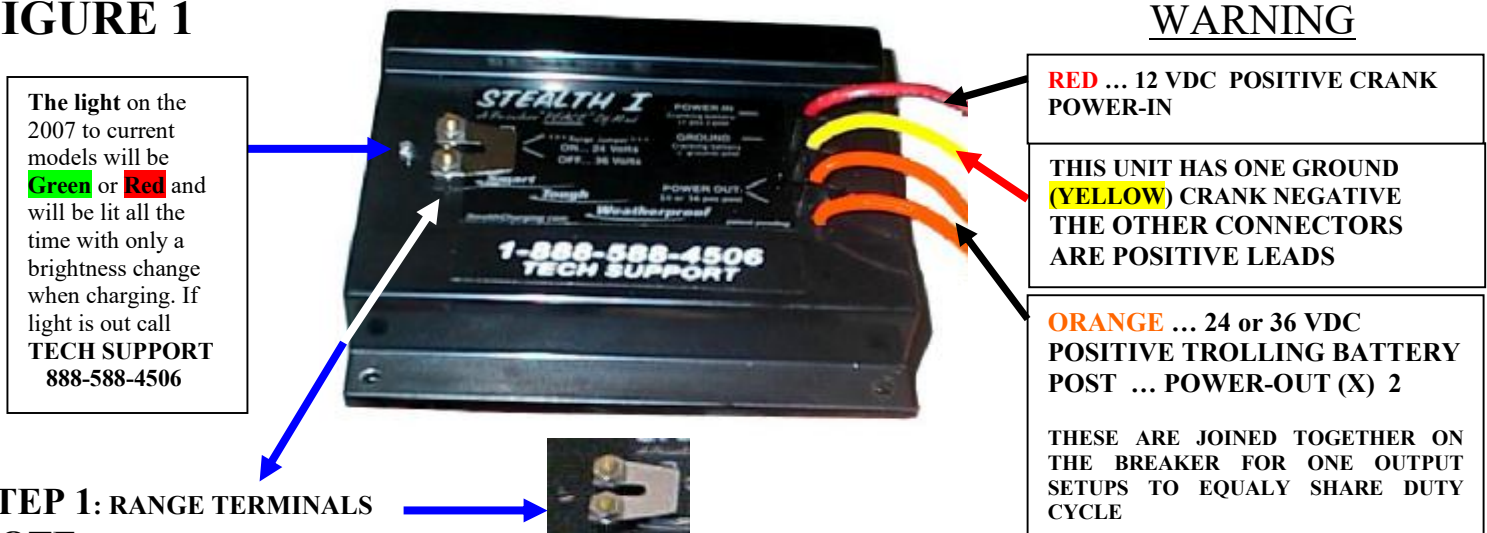

NOTE: If you are unsure what your system requirements are, check with your local marina, boat mechanic, or Stealth I Customer Service.

The Stealth I DC already comes equipped for a 24VDC system. (Jumper on seen above)

(1-888-588-4506)

To convert to 36VDC remove the range jumper seen in (figure 1 step 1)

(For 12 to 12 systems only) please call Tech Support 1-888-588-4506

STEP 2 : COMPONENTS

(4) ¼" Nylon Spacers

(4) ¾" Mounting Screw

(1) Wiring Harness 1 - **RED 4' power-in**; 2 - **YELLOW 4' ground** (crank neg.) and **A 6' ground** neg crank to neg trolling;

1 - **ORANGE 6' trolling power-out**

(4) 3 ½" Mounting Screws : with the Stealth I Pro or Stealth I Max Pack Pro

TOOLS REQUIRED FOR INSTALLATION

Drill... Phillips Screw Driver...3/8 and 5/16 Nut Driver... Volt Meter (May Be Required) makes finding the 24 and 36 volt positive leads easiest

STEP 3 : INSTALLATION

(FOR 12 TO 12 OR 48 VOLT INSTALLATION PLEASE CALL 1-888-588-4506)

1. Mount the Stealth I DC in an area that is least likely to be flooded or submerged. BE SURE and insert the one-quarter inch (1/4") nylon spacers between the bottom of the Stealth I DC and the mounting surface as seen in (Figure 2 below), unless mounted with the Stealth I AC as seen in (Figure 3) with (3 1/2") mounting screws. A vertical mounting position is preferred for both installs (Figure 2).

NOTE: The AC unit is generally mounted behind the DC unit. The AC includes 4 spacers for mounting the DC on top of the AC, but it can be separated if space is limited or the DC was the only unit purchased as in figure 1 above.

*******WARNING*******

There must be a 1/4 inch between the 2 units **YOU CAN NOT STACK WITHOUT VENT SPACE !!!**
NO EXCEPTIONS Even if mounted SEPARATE!!! THERE MUST BE AT LEAST A 1/4 INCH OF AIR
 PASSAGE FROM MOUNTING SURFACE...It's a charger and creates Heat to the Heat Sink on bottom.

Figure 2 DC UNIT ONLY.

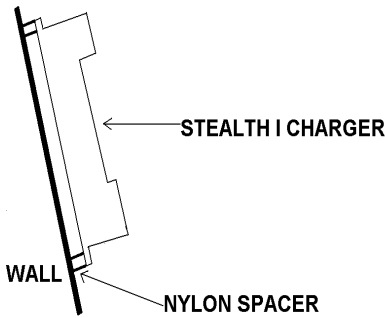

AC lights will go solid green when finished.
 Red/Green is surfacing the crank and trolling
WARNING
Red to green
flashing means
problems
Call Tech
Support



Figure 3 AC and DC piggyback DC UNIT



IMPORTANT REMINDERS:

GROUNDS CONNECTED PROPERLY: Be sure the charger ground **YELLOW** is connected to the **crank battery negative** post and the power input **RED** is to the **positive** post of the **crank battery**. And the other batteries must be common grounded with the 10 gauge **YELLOW** 7' cable included in the wiring harness. (See the grounds in the option pages 3-5)

DC LED LIGHT: When the green or red LED light is on, it indicates that the Stealth I DC is powered and monitoring the batteries as designed.

MAINTENANCE: The breaker terminals and connections should be covered with white/clear grease or corrosion x (or a similar product), which protects against oxidation and corrosion.

BATTERY MAINTENANCE: Periodically checking your trolling batteries is essential for achieving maximum performance from your batteries. At least once a month you should check your battery acid levels and follow your manufacturer's instructions for replenishing the same (For example, if electrolytes are low, you may add distilled water to some batteries if approved by the manufacturer). You should also periodically check your batteries for voltage and look for differences in voltage between your batteries. If there is more than a 2VDC difference between batteries after charging, the affected battery should be professionally tested and/or replaced.

THE STEALTH 1 DIGITAL GAUGE COMPLETES THE FULL BATTERY MAINTENANCE PROGRAM STEALTH 1 WAS DESIGNED TO BE. FOR INFO ON THE GAUGE CALL 888-588-4506.



*****NOTE*****

WHEN LOOKING AT THE OPTIONS... NOTICE ALL BATTERIES ARE COMMON GROUNDED ... THE MOST COMMON MISTAKE IS LEAVING THE GROUNDS OFF.

OPTION #1 24 VOLT SYSTEM WITH AC



Breakers are manual reset only: **Red & Yellow** = 50amp
Orange output = 20 amp

YELLOW OR BLACK COMMON GROUND (NEG CRANK TO NEG TROLLING) GOES TO 24 VOLT NEG POST... (NEG. & POS. THAT DOES NOT HAVE THE JUMPER **A** IS 24VDC CONNECTIONS)

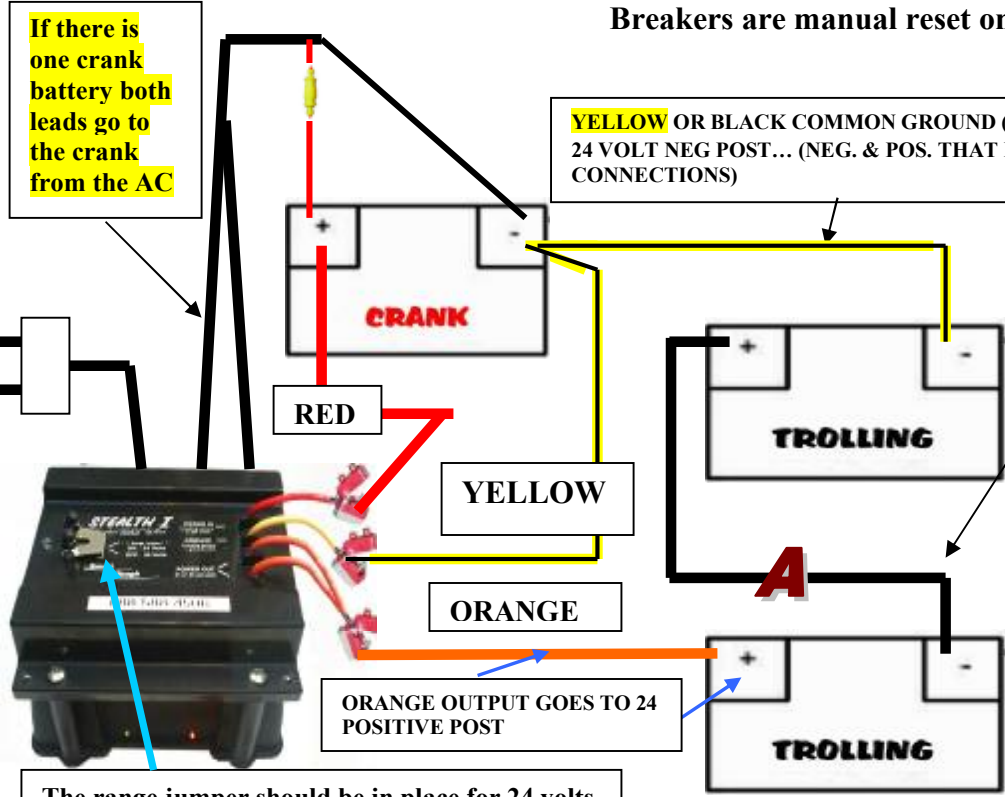

NOTE 1ST STEP

IF THE BATTERIES ARE NOT JUMPED AS SEEN. **YOUR BATTERIES ARE JUMPED IN THE PLUG. YOU DO NOT HAVE TO ADD A JUMPER !!!**

USE A VOLT METER TO FIND THE 24-VOLT POSITIVE AND NEGATIVE.

TAKE THE METER POS. PROBE TO BAT 2 POS. AND THE NEG. PROBE TO THE 1ST BAT NEG. POST.

IF THE READING IS NOT YOUR 24 VOLTS THEN REPEAT (ABOVE) AND CHANGE POSITIVE TO BAT 1 NEGATIVE TO BAT 2

The range jumper should be in place for 24 volts

IF YOU ARE NOT SURE CALL TECH SUPPORT 888-588-4506

OPTION #2 36 VOLT SYSTEM WITH AC

If there is one crank battery both leads go to the crank from the AC.
Reds pos **Blacks neg**

YELLOW or BLACK common ground

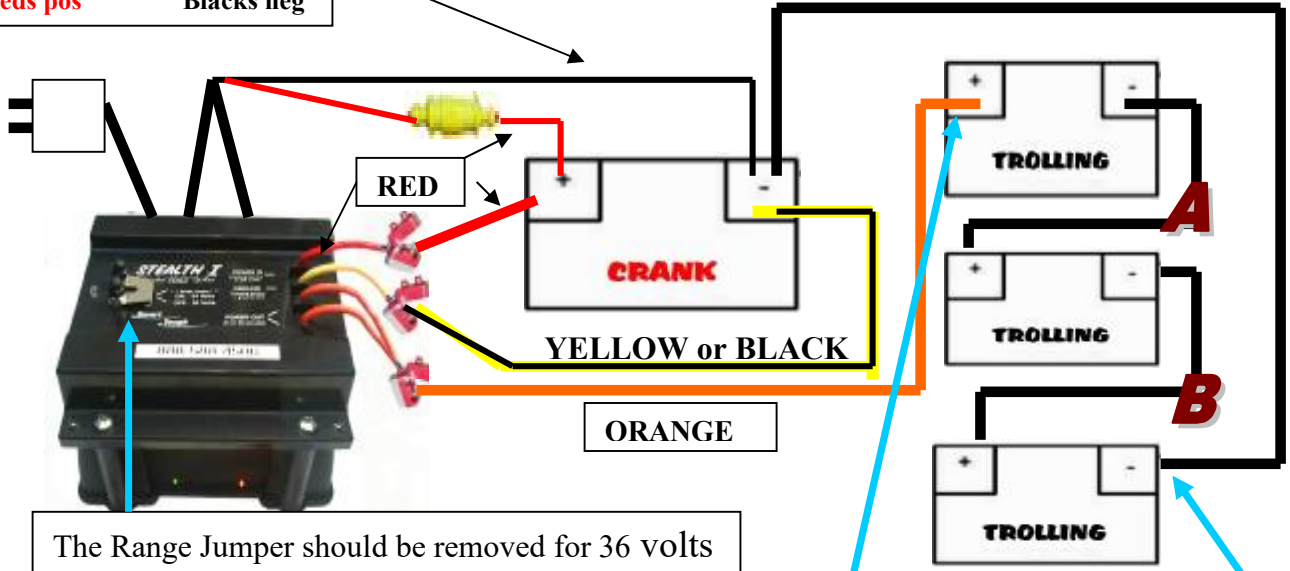

The Range Jumper should be removed for 36 volts

ALL WIRE 10 GAUGE OR BIGGER

The 2 post without a jumper connected on the Batteries are your 36 VDC leads

OPTION #3

36 VOLT SYSTEM CRANK as TROLLING WITH AC

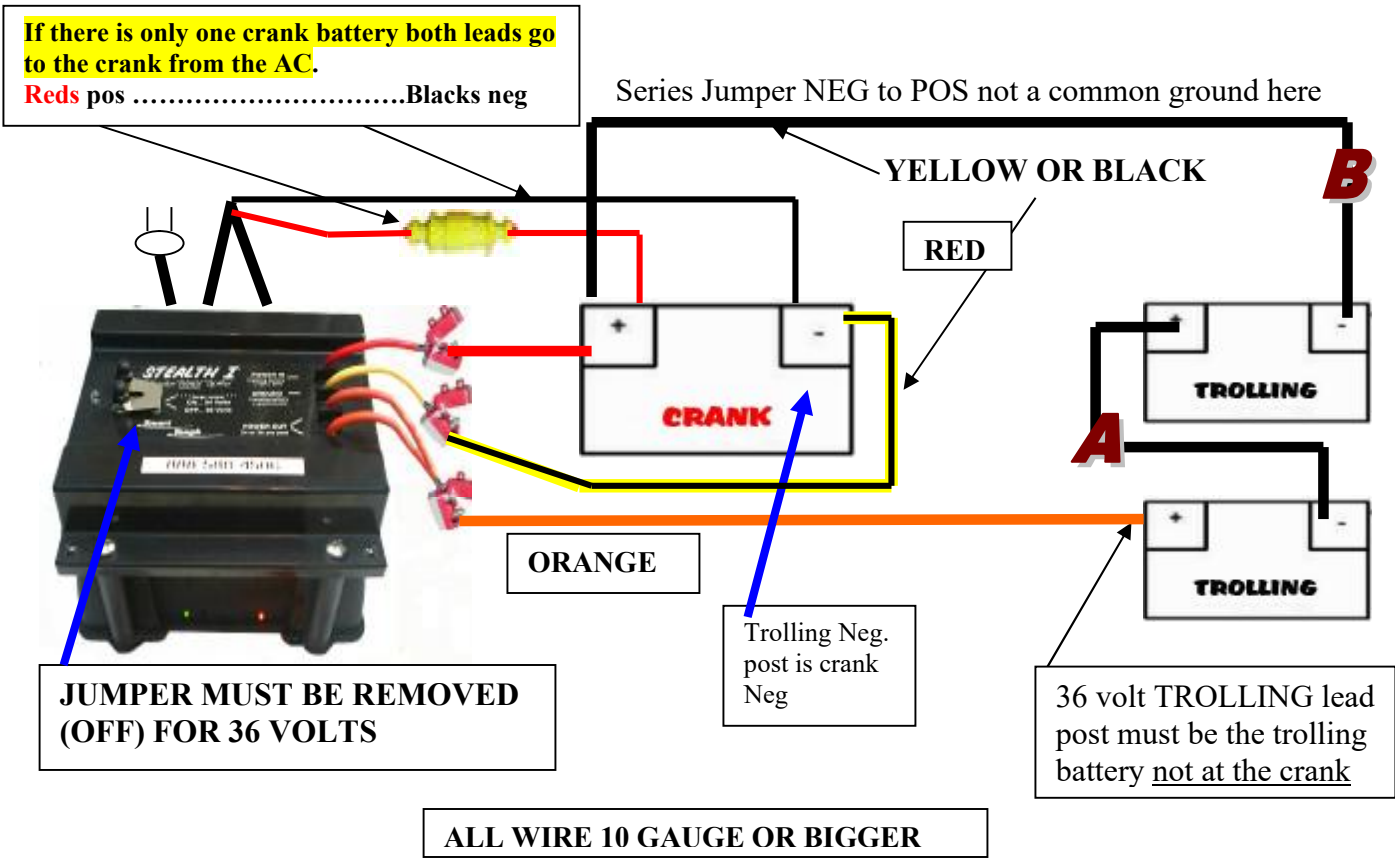

OPTION #4

24 VOLT SYSTEM CRANK as TROLLING WITH AC

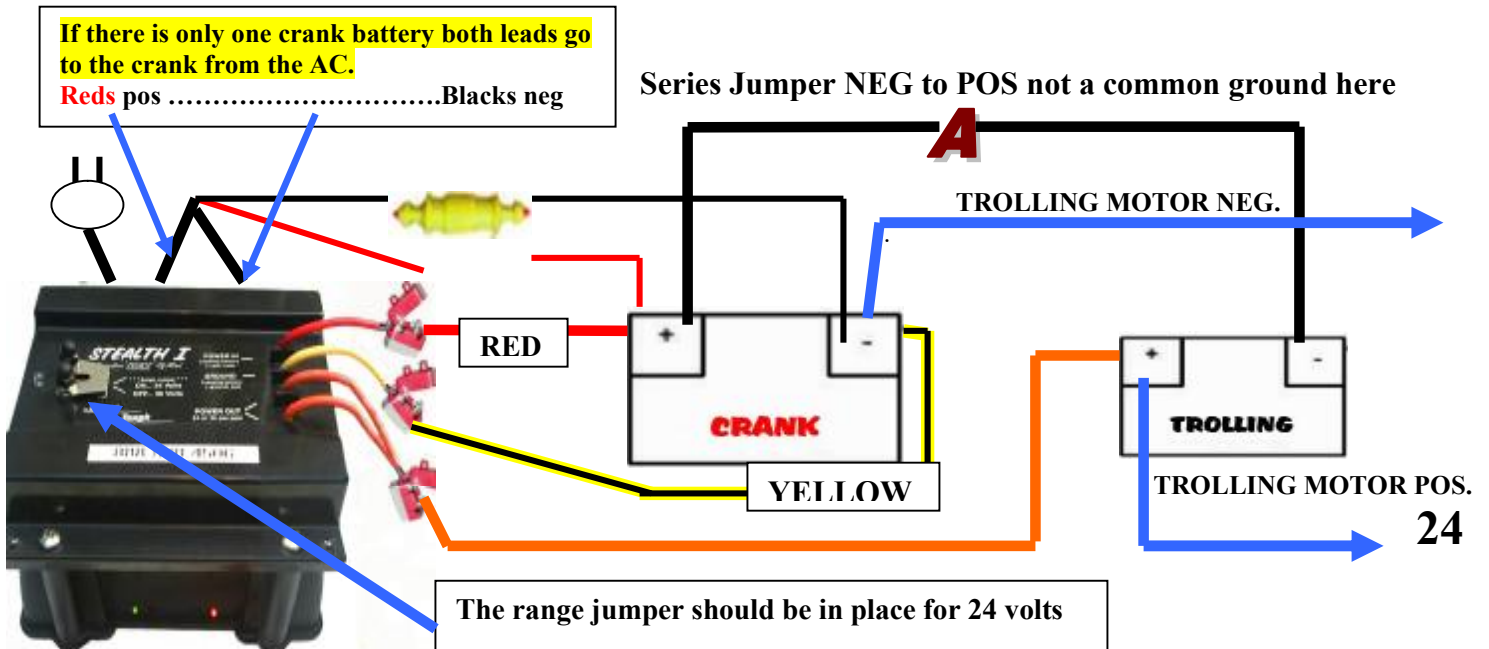

Option #5

24 V SYSTEM WITH BATTERY SWITCH SHARING TROLLING BATTERY FOR EMERGENCY STARTING

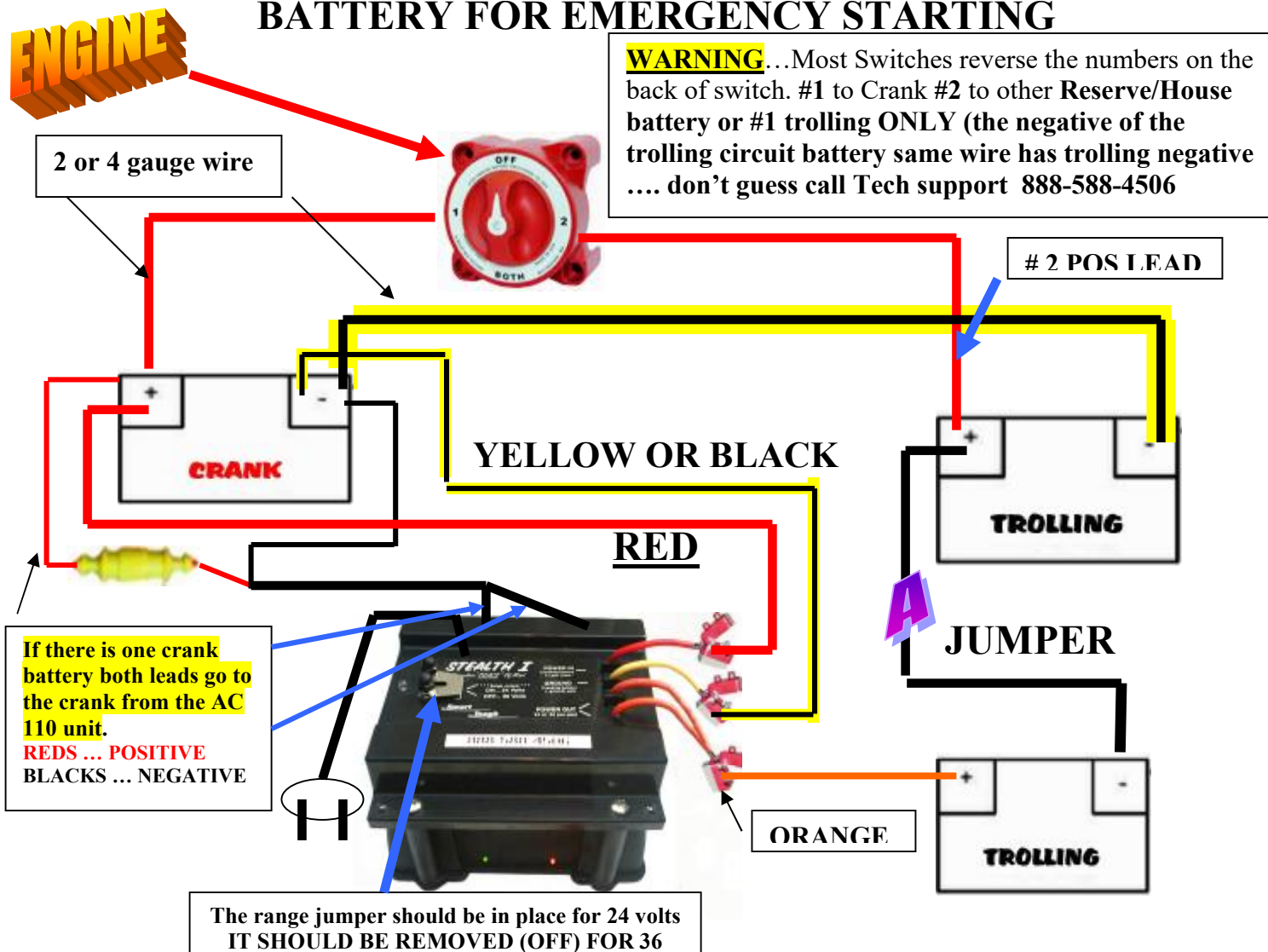

NOTE

- *When charging with Shore power/AC 120 turn battery switch to (# 1) or (off) position.
- *When the boat is in operation battery switch should be in the (#1) one position if setup as power disconnect also, If not turn off.

With this (diagram/setup) the number 1 battery in the 24 or 36 volt bank becomes the number 2 cranking battery **(NOTE: THE NUMBER 1 BATTERY WILL ALWAYS BE THE NEGATIVE OF YOUR TROLLING CIRCUIT CALL TECH SUPPORT IF YOU ARE NOT SURE... THIS IS A MUST... DON'T GUESS)** and for usage turn to (1 & 2 both, all) on the battery switch for emergency starting. Run 2 to 5 min. and back to 1 or off.

SEE THE (2 GAUGE) STARTING CABLE GOING TO THE #1 BATTERY POSITIVE FROM THE SWITCH POSITION # 2 IN THE DIAGRAM LISTED (#2 POS LEAD on the Back of switch) ALSO THE GROUND GOING TO THE CRANKING BATTERY MUST BE 2 GAUGE FOR STARTING.

NOTE

If your batteries are not jumped as seen above (**A**)

refer to ...OPTION 1 **NOTE 1ST STEP** and proceed to find the correct

battery post for hook up.

Option #6

36 V SYSTEM WITH BATTERY SWITCH SHARING TROLLING BATTERY FOR EMERGENCY STARTING

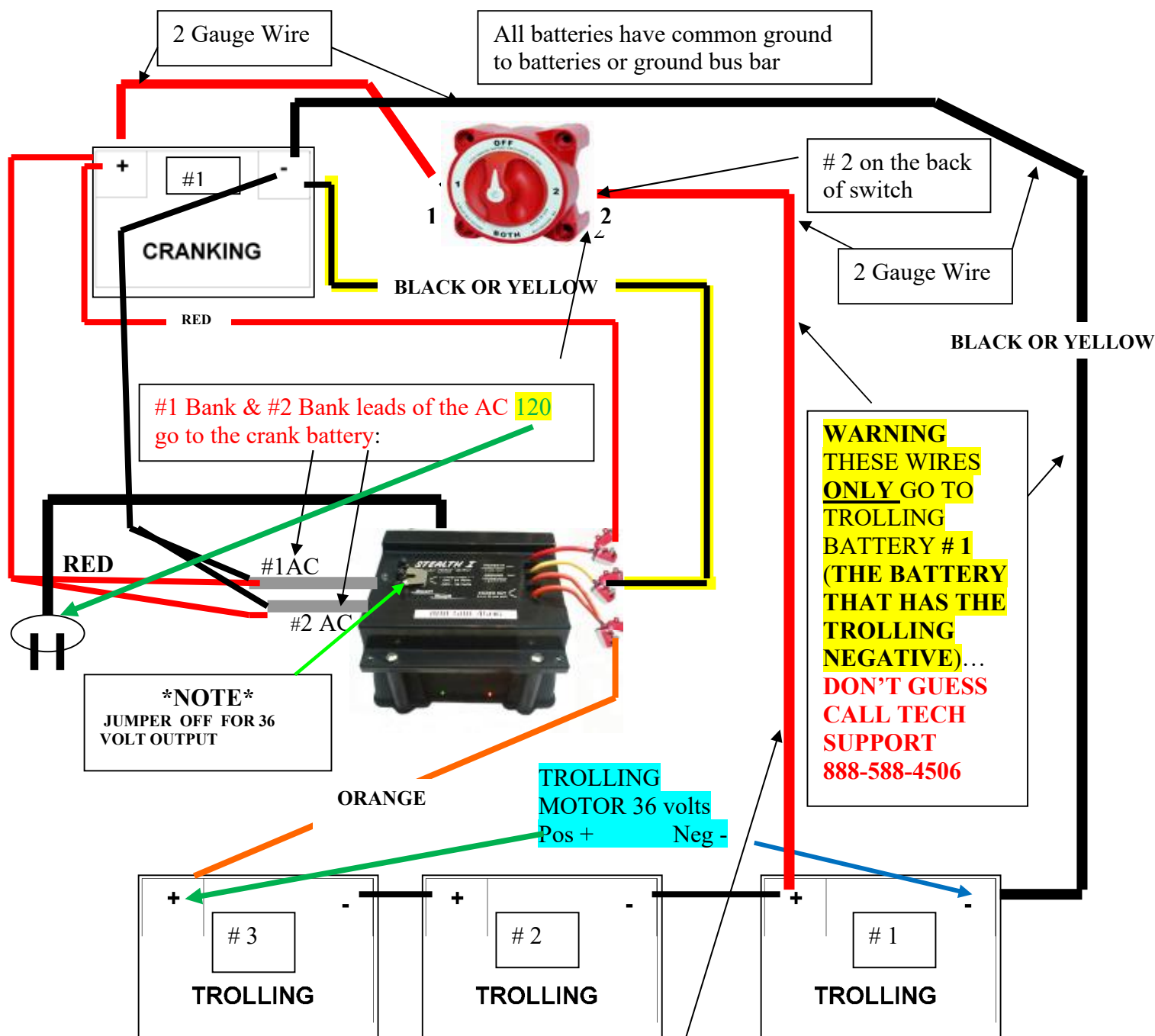

*When charging with Shore power/AC 120 turn battery switch to (# 1) or (off) position.
 *When the boat is in operation battery switch should be in the (#1) one position if setup as power disconnect also, If not turn off.

With this (diagram/setup) the number 1 battery in the 24 or 36 volt bank becomes the number 2 cranking battery (NOTE: THE NUMBER 1 BATTERY WILL ALWAYS BE THE NEGATIVE OF YOUR TROLLING CIRCUIT CALL TECH SUPPORT IF YOU ARE NOT SURE... THIS IS A MUST... DON'T GUESS) and for usage turn to (1 & 2 both, all) on the battery switch for emergency starting. Run 2 to 5 min. and back to 1 or off.

SEE THE (2 GAUGE) STARTING CABLE GOING TO THE #1 BATTERY POSITIVE FROM THE SWITCH POSITION # 2 IN THE DIAGRAM LISTED (#2 POS LEAD on the Back of switch) ALSO THE GROUND GOING TO THE CRANKING BATTERY MUST BE 2 GAUGE FOR STARTING. **Other Diagrams are available**
888-588-4506

Most **IMPORTANT**...Does It Work? YOU CAN KNOW IT!

Lets test it. After everything is hooked up as in the diagram for your application let's make sure everything works correctly.

1...If Stealth's voltmeter is attached to the output of the charger or the positive post of the trolling or aux batteries and is located in the console or for you to see. We can use Stealth's voltmeter for this test. If not you will need a *digital voltmeter (it must be digital)*.

2...Now we disconnect the orange power out cable from the positive battery post

3...Now we have taken the battery load off of the charger.

(A) If you are using the Stealth voltmeter you take the lead (letter E At the gauge) from the output breaker post or battery positive on the trolling or aux batteries and lay it to the side it is your voltmeter. It will be a small wire size (22 to 16) and your gauge after disconnect will read 7 to 8 volts. If this is your application, which is Stealth's preference for installation as pictured on (page 9), then go to step #4. Our gauge was designed for this purpose of maintenance. (Note if your gauge is installed in the bow you cannot use it for this test)

(B) If you are using a Digital voltmeter set it to DCV; 50 or the next voltage setting on the meter.

4...Now plug in the AC 110 portion of the Charger.

5...Now if you are using the Stealth1 voltmeter you take the (22 to 16 gauge) lead in hand to use to check voltages. Hold it to the input breaker post (**Red wire**) labeled *POWER In at the charger* beside the **Red wire** (AS SEEN ON PAGE 1 FIGURE 1). Look at the meter allow it to settle and write down the voltage. It must be above 13 volts. If not allow it to charge the crank for few minutes then try again. Once you have reached 13 volts go to step 6.

If you are using a digital voltmeter then take the pos. and neg. leads in hand. Now go to the power in BREAKER and the ground BREAKER for the reading. Results should be 13 or above

6...Now if the results are 13 volts or above, Stealth meter users take the lead to the power out BREAKER **Orange** and write it down. Do the same at the end of the **Orange** cable and the voltage should be the same.

Digital hand held takes the neg. probe to the ground breaker or a common ground and the pos to the power out Orange breaker and write it down. Then to the end of the Orange cable and the voltage should be the same.

We have now checked the in-put voltage the charger is monitoring and the out-put voltage the charger is monitoring. Specks should be 27.0 to 28.3 for 24-volt systems and 41.0 to 42.3 for 36-volt systems. If not or any questions please call Tech support @ **888-588-4506**.

7...Now unplug the AC. Then hook the orange output cable back up to the charger or the battery Positive. After reconnecting the **Orange** output, plug in the AC and verify that the trolling or aux batteries voltage is climbing at the batteries. Hand held meter (24 volt) battery #2 pos. to bat #1 neg. & (36 volt) bat #3 pos. to bat #1 neg. Stealth meter users hold to 24 or 36 volt battery #2 or #3 positive. Again just verifying that the voltage is climbing. If it's climbing you are good to go. NOW YOU KNOW and If not PLEASE call tech support **888-588-4506**

TROUBLESHOOTING GUIDE



DC UNIT

Breakers: **Red & Yellow** = 50amp, **Orange** output = 20 amp. Manual reset only (black reset button at the end)

1. MY GREEN OR RED LIGHT DOES NOT COME ON

Check the breakers. Check the wiring diagram. (Power-In to positive cranking, negative cranking to ground) .

2. MY CRANKING BATTERY IS NOT CHARGING

Check the water level in your battery, put a load test on it to make sure it does not have a bad cell. Check the fuse on the Stealth I AC. (YELLOW GLASS HOLDER may be shrink wrapped gray.

3. ONLY ONE OF MY TROLLING/AUX. BATTERIES IS CHARGING

Check your wiring diagram. Check your jumper tab on the left side of the Stealth I DC right beside the light. It should be on for 24 volt system and off for 36 volt system. Make sure you are on the correct battery post see the options above. Load test the battery.

4. MY TROLLING/AUX. BATTERIES ARE NOT CHARGING

Make sure the switch is on if rigged to a battery switch. Make sure you have a green light on the Stealth I DC. Check the breakers. Make sure your batteries are jumped together and properly common grounded (SEE OPTIONS ABOVE). Check the wiring diagram for all wires properly placed. Do a load test on the batteries.

5. HOW CAN I CHECK THE OUTPUT ON THE UNIT

Disconnect the power out from the batteries. Put a voltmeter on the ground and power out on the Stealth I DC and you should get a reading between 27.4 – 28.3 Volts (24 Volt System) or 41 – 42 Volts (36 Volt System).

AC UNIT

1. I DO NOT GET GREEN LIGHTS SHOWING FULL CHARGE OR MY LIGHTS ARE FLASHING.

Check the fuse. Check for clean and tight connections. Check the water level in the batteries. Load test the batteries.

2. I DO NOT HAVE ANY LIGHTS ON

Make sure the Stealth I AC is plugged into AC power. Check extension cord. Call tech support. **1-888-588-4506**

DIGITAL GAUGE

IF YOU DO NOT HAVE A STEALTH I DIGITAL GAUGE, CALL 1-888-588-4506 FOR A LOCATION NEAR YOU.

1. I AM NOT GETTING A READING ON MY GAUGE

Check your wiring diagram and make sure there are no loose connections.



IF THESE SOLUTIONS DO NOT WORK, PLEASE CALL OUR TECH SUPPORT NUMBER 1-888-588-4506.

WARRANTY: The Stealth I DC has a three year unlimited warranty. The AC pro-rates the third year and the Gauge prorates over three years (Warranty registration card included)

For more information about the Stealth I Charging System, or if you have any questions or comments, contact us at:

Stealth 1 Charging
ChargTech Industries
7428 Hixson Pike
Hixson, TN 37343

Toll Free 1-888-588-4506
Phone (423) 842-2772
Fax (423) 842-2784

E-Mail: StealthCharging@aol.com
www.stealth1charging.com

BLUE GAUGE

<u>Must Charge</u>	Conventional Batteries	<u>Healthy</u>
12v = 12.3		12v = 12.6
24v = 24.7		24v = 25.3 +
36v = 37.1		36v = 37.9 +

Gauge Install

Red Wire or White.... 12 volt console key or switched on/off ...to power on and off with key or main Battery switch.

Yellow Wire or Black... Any ground...Console or Battery

Any color Wire... Trolling battery positive or DC breaker orange !!! middle colored wire

This gauge reads both circuits (**trolling and crank**) With one glance for info on performance and health of your battery system.

2 1/8 Hole

"A Priceless Peace of Mind"

RED GAUGE

<u>Must Charge</u>	Lithium Numbers Only	<u>Healthy</u>
12v - 12.9-		12v - 13.2+
24v - 25.8-		24v 26.8+
36v - 39.6-		36v = 41.0+

Gauge Install

Red Wire or White.... 12 volt console key or switched on/off

Yellow Wire or Black... Any ground... Console or Battery

Any color Wire... Trolling disconnect trolling g breaker or switch !!! Will read trolling circuit

This gauge not only reads both circuits (**trolling and crank**) but will also show the boat is properly shut down. The LED read outs will power from both sides Showing the reading for the one not disconnected...So read both circuits and the last glance of the gauge with all cut off no draw and gauge will be out... If it's still on it will show the reading of the one on and 0.00 for the one off a reminder to shut down the one still ... *"A Priceless Peace of Mind"*

18scsdbble-rd & 18scsdbble-bl Gauge

Is completely **submersible** with a double read out up to 60 volts @ 2

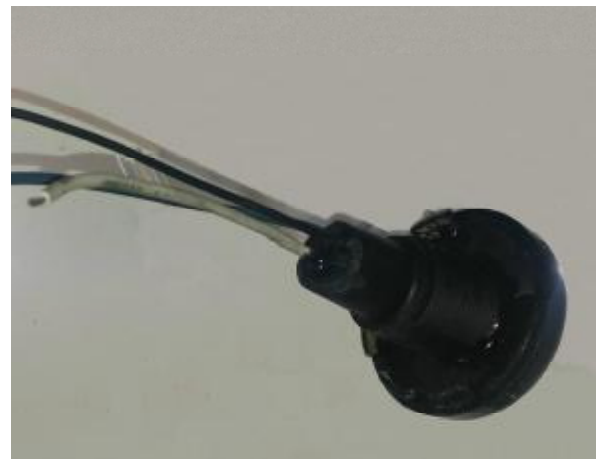

www.ChargeOnTheRun.com

888-588-4506

Stealth 1 vf55 Gauge

This Gauge is designed to read 9 to 44 volts DC. It is powered with the **B** connection **12 volts Positive only** and switched on/off from key or main switch power.

Hook to 12volt power on and off under console (to find 12volt (on/off) use a voltmeter to locate connection point)

Grounded with the **A** connection (*any ground because we are common grounded*).

C Nothing

The **D** terminal is the **backlight**. If your console Gauges light up with (**key or main on**) then loop **B** to **D** and the back light will respond as all the other gauges. If you manually turn back lights on with **NAV** Switch then D to **NAV** switch on/off

E is the actual voltmeter that is reading the voltage from 9 to 44 volts DC. Allowing you the user to step on your boat and instantly check your power conditions. It hooks up to the Stealth 1 DC orange wire breaker or trolling positive to read your trolling circuit.

Full charged readings are as follows...12 volts is 12.65... 24volts is 25.3 and 36 volts is 37.9 each battery being 12.65 or **better (surface readings)** is a charged battery.

MUST plug in.... The Stealth system is to keep the batteries Healthy **A SYSTEM.** to start the process over again USE THESE NUMBERS

12 VOLT = 12.3..... 24 VOLT = 24.7.....36 VOLT = 37.2

FOR THE HEALTH OF THE BATTERIES PLUG IN IF THE CRANK OR TROLLING IS BELOW THESE NUMBERS



To calibrate the Stealth Gauge...**turn gauge off...**with gauge off **Hold the down button in while you turn power on** (will beep after powered) after beep **count to 04 and release down button** it is now ready to set so **read your circuit** then set with up down buttons...once you are at your setting **wait 5 seconds make sure it stays on your setting...**now **save by the plus(+)** key for 1 second then release.

Any questions please call ***Tech Support 888-588-4506.***



www.ChargeOnTheRun.com

Operation



Key Functions

The    keys are used to select what to display, backlights, calibrate volts, turn alarms on/off and set alarm values. New information is automatically saved to memory.

Turning Alarms ON/OFF





Press the  key 1/2 second to turn alarms ON. The alarm icon pointer will blink. Press the  key 1/2 second to turn the alarms OFF.

Backlight Intensity

Press the  key 1/2 second to adjust the backlight level for night-time viewing. Each time you press the  key 1/2 second, the level will get brighter 1,

Page 10



Setting Low Volts Alarm

Press and hold the  key for ten (10) seconds. You will hear a beep and the Low Volts alarm value will be displayed. Use the  and  keys to set the desired alarm value. Press the  key for 1/2 second to save the Low Volts Alarm value to memory.

Page 12

Selecting NMEA 0183 or External Alarm Output

The monitor comes factory pre-set to output NMEA 0183 compatible serial data. If you do not need this feature or would rather have an external alarm output on screw terminal (C), do the following:

While viewing battery voltage, press and hold down both the  and  keys for 10 seconds (until you hear a long beep). This operation switches the output mode between NMEA 0183 and External Alarm. The new output mode is automatically saved to memory.

When the external alarm output is activated, a 5V signal (10 mA Max.) is output on screw terminal (C).

Page 14





2, 3, 4, OFF, 1, 2, ... etc. Screw terminal pin (D) must be switched ON for the backlights to work.

Display Volts

Quick press the  key to display volts







Setting High Volts Alarm

Press and hold the  key for ten (10) seconds. You will hear a beep and the High Volts alarm value will be displayed. Use the  and  keys to set the desired alarm value. Press the  key for 1/2 second to save the High Volts Alarm value to memory.

Page 11

Calibrating the Instrument

The voltmeter can be calibrated at any time by using the front panel keys. To calibrate the voltmeter, press and hold down the  key for three seconds while applying power to the instrument. Use the  and  keys to make the displayed value read correctly. Press the  key to save the calibration data to memory.

Page 13

Warnings and Notes

1. Screw terminal (D) must be connected to 9.5 VDC minimum in order for the backlights to turn ON. If screw terminal (D) is not connected to at least 9.5 VDC the backlights will turn OFF. This provides remote control of the backlights.

Page 15

FREQUENTLY ASKED QUESTIONS ABOUT THE STEALTH CONTINUOUS CHARGING SYSTEM

Q. WHAT IS THE STEALTH SYSTEM?

A. THE STEALTH SYSTEM IS THE MOST ADVANCED, PATENTED, SOLID STATE BATTERY MAINTENANCE SYSTEM AVAILABLE ON TODAY'S MARKET.

Q. WHAT IS THE SYSTEMS FUNCTION?

A. THE STEALTH SYSTEM TAKES VARYING INPUTS OF VOLTAGE, WHETHER FROM A GENERATOR / ALTERNATOR, OR AN A/C POWER SOURCE, AND DELIVERS PURE OUTPUT POWER TO CHARGE AUXILIARY BATTERY BANKS SIMULTANEOUSLY, TO KEEP THEM AT MAXIMUM READINESS LEVELS.

Q. WHAT ARE OTHER ADVANTAGES OF THE SYSTEM?

A. FOR VARYING REASONS, THIS PATENTED CHARGING METHOD LETS THE BATTERIES ABSORB THE CHARGE LIKE A 'SPONGE' INSTEAD OF HAVING THE CHARGE 'RAMMED' INTO THE BATTERIES. THE INTERACTION BETWEEN THE STEALTH CHARGING SYSTEM AND THE BATTERIES KEEPS THE BATTERIES 'HEALTHIER', AND MORE CONSISTENTLY CHARGED. THIS LENDS ITSELF TO EXTENDING THE BATTERY'S LIFE SIGNIFICANTLY.

Q. WHY WAS THE STEALTH SYSTEM CREATED?

A. THERE WAS A DEMAND IN THE BASS FISHING INDUSTRY TO BE ABLE TO KEEP AUXILIARY (TROLLING MOTOR) BATTERIES CHARGED IN EXTREME DEMAND CONDITIONS, TO EXTEND FISHING TIME. THE AUXILIARY BATTERIES ARE CONTINUOUSLY CHARGED USING THE 'HOST' VEHICLES ELECTRICAL GENERATION SYSTEM. THE SYSTEM CAN EVEN CHARGE WHILE THE BOAT IS IN TOW USING THE VEHICLES POWER OUTPUT

QUESTIONS AND ANSWERS CONTINUED

Q. HAS THIS SYSTEM PROVEN TO BE EFFECTIVE?

A. YES. ASK THE PROS WHO CURRENTLY HAVE THE STEALTH SYSTEM ON THEIR BOATS. OFTEN TIMES THE ADVANTAGES THE STEALTH SYSTEM PROVIDES WILL BE THE 'WINNING EDGE' NEEDED BY EXTENDING PRODUCTIVE FISHING TIME. MAGAZINES SUCH AS (POWER BOATS, BASS & WALLEYE, BASS, BOAT & TRAILER) AND MANY MORE HAVE WRITTEN ABOUT THE TECHNOLOGY. AWARDS, INTERVIEWS, SHOWS, AND RETAILERS SUCH AS BASS PRO, CABELAS, AND MANY DEALERS STOCK THE PRODUCT. OEMS ALSO ARE INSTALLING THEM AT THE FACTORY NOW SO ASK YOUR REP.

Q. WHAT IS THE STEALTH A/C?

A. FISHERMAN KNEW THAT ALTHOUGH THEY MIGHT NOT NEED TO CHARGE THEIR BATTERIES, WITH AN A/C UNIT NEARLY AS FREQUENTLY AS IN THE PAST, THEY WANTED THE OPTION TO DO SO READILY AVAILABLE. SO WE CREATED THE STEALTH A/C.

Q. HOW DOES THE STEALTH A/C ATTACH?

A. THE STEALTH A/C UNIT WILL MOUNT ON ANY STEALTH I D/C UNIT, WITH THE PROPER BOLTS AND SPACERS. THE STEALTH A/C UNIT MOUNTS IN A 'PIGGY BACK' MANNER, TO FORM THE STEALTH MAX-PAK. THE MAX-PAK NOW PROVIDES ALL YOU WILL EVER NEED IN AN 'ON BOARD' CHARGING SYSTEM, SINCE IT PROVIDES A/C PLUG IN CAPABILITY TO COMPLIMENT THE STEALTH D/C UNIT AND VOLTAGE GAUGE.

Q. ARE THEIR OTHER ADVANTAGES TO USING THE STEALTH SYSTEM?

A. YES. SINCE THE STEALTH SYSTEM CAN TAKE VARYING INPUTS OF D/C CURRENT, AND GIVE A CONSTANT D/C OUTPUT VOLTAGE AT CONSISTENT EFFICIENCY LEVELS NEVER BEFORE OBTAINED, THIS ALLOWS A BOAT OWNER TO CONSIDER THE USE OF OTHER SOURCES OF INCONSISTENT D/C POWER INPUT. SUCH AS SOLAR, WIND, OR WATER POWER GENERATORS AND THE TOW PACKAGE

QUESTIONS AND ANSWERS CONTINUED

A. (CONTD)

THIS COULD INCLUDE SUCH THINGS AS SOLAR PANELS FOR EXAMPLE. THE ABILITY TO BE PAIRED WITH THE STEALTH A/C UNIT ASSURES THE BOAT OWNER THAT HE IS ALWAYS "GOOD TO GO".

Q. IT APPEARS THAT THE SYSTEM WOULD ALLOW FOR MANY OTHER POTENTIAL APPLICATIONS. IS THIS TRUE?

A. YES. IN FACT THE DEVELOPEMENT OF THE STEALTH MAX-PAK OPENS DOORS FOR APPLICATIONS TO LARGER BOATS, BOTH PLEASURE AND COMMERCIAL, WHERE A 'BANK' OF AUXILIARY BATTERIES, 'OR HOUSE BATTERIES', CAN REMAIN CONSISTENTLY CHARGED FOR SUCH USES AS RUNNING LIGHTS, RADIOS, G. P. S. SYSTEMS, SONAR, AND OTHER SOPHISTICATED ELECTRONIC EQUIPMENT. THE STARTING BATTERY

REMAINS ISOLATED WITH THE STEALTH SYSTEM AND THEREFORE DOES NOT RUN DOWN. AN ADDITIONAL ADVANTAGE WITH THE STEALTH SYSTEM IS THAT IT ALLOWS FOR THE USE OF AN AUXILIARY BATTERY TO BE USED AS A STARTING BATTERY, IN THE EVENT OF A STARTING BATTERY FAILURE.

Q. WHAT ARE SOME OTHER POTENTIAL APPLICATIONS FOR THE STEALTH SYSTEM?

A. THE STEALTH MAX -PAK, FOR EXAMPLE, WOULD ALLOW GOLF CART OWNERS TO BE INDEPENDENT. THE LIGHT WEIGHT STEALTH SYSTEM WOULD ALLOW A GOLF CART TO PULL UP TO ANY 110V A/C OUTLET, WHERE EVER IT IS, AND CHARGE UP. OR THE SOLAR PANEL PACK WHICH WOULD HANDLE 90% TO 100% OF THE CHARGE BACK. R&D HAS PROVEN THIS KIND OF EFFICIENCIES IN THE STEALTH TECHNOLOGY. SO YOU CAN SEE ANY PLACE THERE IS MORE THAN ONE BATTERY STEALTH APPLIES BECAUSE THE POWER INPUT CAN COME FROM ANY WHERE

Also the Tow Package is available

40 amps while towing.

Easy install Harness

Make AC take a backseat

No hassle battery charging (just go fish)

Who cares whether I can get to an outlet

And again on the run charging (just drive)

Call and ask about your system...

888-588-4506